

# Objet Insolite

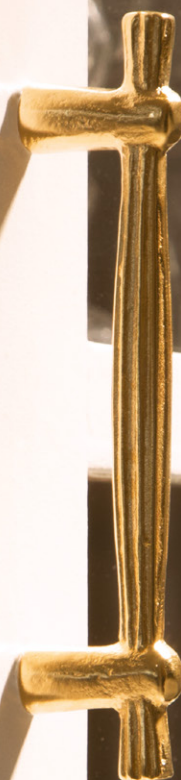

**TARIF 2021**  
QUINCAILLERIE

**PUBLIC PRICE**  
PRIX PUBLIC T.T.C.

# TIRAGE | PULLS

## BÉLIER

BOUTON DE TIRAGE | KNOBS

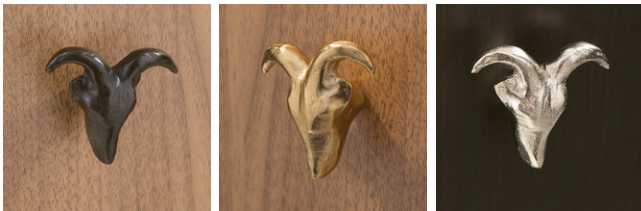

PATINÉ | BROWN

DORÉ | GOLD

NICKELÉ | NICKEL

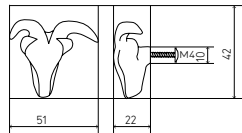

BÉLIER

BÉLIER	PATINÉ BROWN	DORÉ GOLD	NICKELÉ NICKEL
par 20   by 20	24,38	58,50	52,91
par 1   by 1	27,87	68,24	61,71

## COROLLA

BOUTON DE TIRAGE | KNOBS

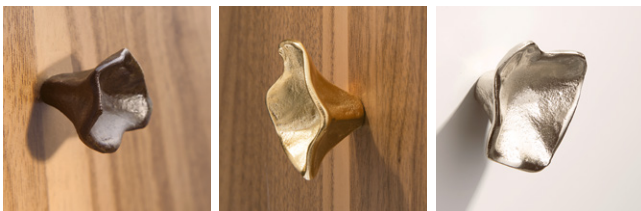

PATINÉ | BROWN

DORÉ | GOLD

NICKELÉ | NICKEL

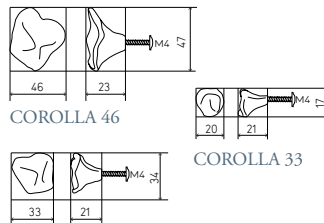

COROLLA 20

COROLLA 33

COROLLA 46	PATINÉ BROWN	DORÉ GOLD	NICKELÉ NICKEL
par 20   by 20	21,14	55,73	50,09
par 1   by 1	24,16	65,01	58,45
COROLLA 33			
par 20   by 20	17,84	47,85	41,34
par 1   by 1	20,37	55,81	48,22
COROLLA 20			
par 20   by 20	15,07	41,78	34,72
par 1   by 1	17,23	48,75	40,48

## LAPIN

BOUTON DE TIRAGE | KNOBS



PATINÉ | BROWN

DORÉ | GOLD

NICKELÉ | NICKEL

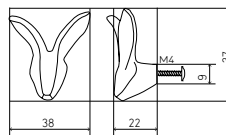

LAPIN

LAPIN	PATINÉ BROWN	DORÉ GOLD	NICKELÉ NICKEL
par 20   by 20	19,43	49,19	42,70
par 1   by 1	22,20	57,42	49,81

## ÉCAILLE

BOUTON DE TIRAGE | KNOBS

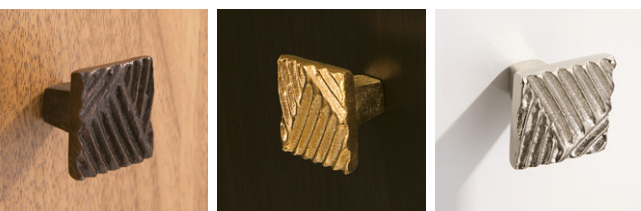

PATINÉ | BROWN

DORÉ | GOLD

NICKELÉ | NICKEL

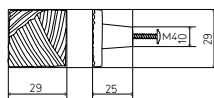

ÉCAILLE 29



ÉCAILLE 19

ÉCAILLE 29	PATINÉ BROWN	DORÉ GOLD	NICKELÉ NICKEL
par 20   by 20	21,69	56,19	50,60
par 1   by 1	24,79	65,56	59,03
ÉCAILLE 19			
par 20   by 20	16,74	43,19	36,10
par 1   by 1	19,12	50,40	42,13

**GALON**  
BOUTON DE TIRAGE | KNOBS

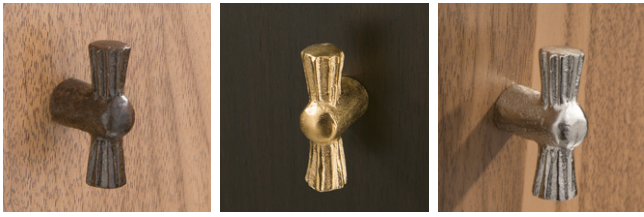

PATINÉ | BROWN

DORÉ | GOLD

NICKELÉ | NICKEL

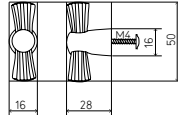

GALON 50

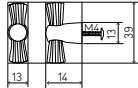

GALON 39

	PATINÉ BROWN	DORÉ GOLD	NICKELÉ NICKEL
<b>GALON 50</b>			
par 20   by 20	<b>23,91</b>	<b>53,04</b>	<b>46,55</b>
par 1   by 1	27,50	61,89	54,34
<b>GALON 39</b>			
par 20   by 20	<b>17,84</b>	<b>44,13</b>	<b>37,07</b>
par 1   by 1	20,37	51,48	43,23

**ONDES**  
BOUTON DE TIRAGE | KNOBS



PATINÉ | BROWN

DORÉ | GOLD

NICKELÉ | NICKEL



ONDES 30

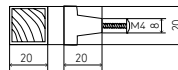

ONDES 20

	PATINÉ BROWN	DORÉ GOLD	NICKELÉ NICKEL
<b>ONDES 30</b>			
par 20   by 20	<b>28,12</b>	<b>61,71</b>	<b>56,10</b>
par 1   by 1	32,14	71,98	65,45
<b>ONDES 20</b>			
par 20   by 20	<b>18,74</b>	<b>44,92</b>	<b>37,86</b>
par 1   by 1	21,43	52,38	44,11

**LEAF**  
BOUTON DE TIRAGE | KNOBS



PATINÉ | BROWN

DORÉ | GOLD

NICKELÉ | NICKEL

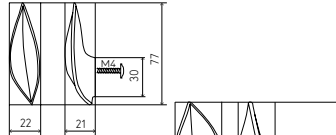

LEAF 77

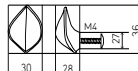

LEAF 36



LEAF 62

	PATINÉ BROWN	DORÉ GOLD	NICKELÉ NICKEL
<b>LEAF 77</b>			
par 20   by 20	<b>21,49</b>	<b>56,03</b>	<b>50,45</b>
par 1   by 1	24,60	65,38	58,85
<b>LEAF 62</b>			
par 20   by 20	<b>20,22</b>	<b>54,96</b>	<b>49,32</b>
par 1   by 1	23,12	64,09	57,55
<b>LEAF 36</b>			
par 20   by 20	<b>16,74</b>	<b>46,88</b>	<b>40,37</b>
par 1   by 1	19,12	54,69	47,12

**CONTIS**  
BOUTON DE TIRAGE | KNOBS

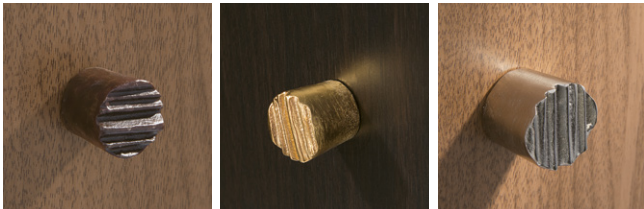

PATINÉ | BROWN

DORÉ | GOLD

NICKELÉ | NICKEL

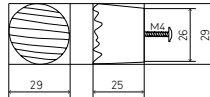

CONTIS 29

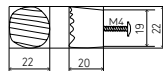

CONTIS 22

	PATINÉ BROWN	DORÉ GOLD	NICKELÉ NICKEL
<b>CONTIS 29</b>			
par 20   by 20	<b>33,44</b>	<b>66,29</b>	<b>60,68</b>
par 1   by 1	38,24	77,31	70,80
<b>CONTIS 22</b>			
par 20   by 20	<b>19,67</b>	<b>45,72</b>	<b>38,63</b>
par 1   by 1	22,48	53,35	45,08

**CROIX**  
BOUTON DE TIRAGE | KNOBS

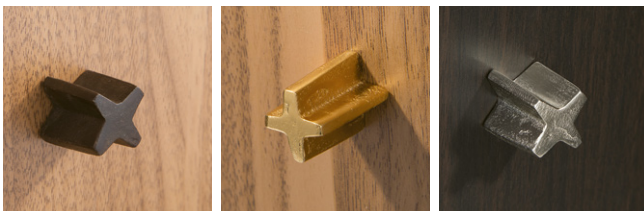

PATINÉ | BROWN

DORÉ | GOLD

NICKELÉ | NICKEL

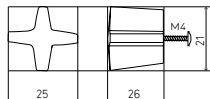

CROIX 25

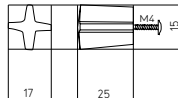

CROIX 17

	PATINÉ BROWN	DORÉ GOLD	NICKELÉ NICKEL
<b>CROIX 25</b>			
par 20   by 20	<b>21,14</b>	<b>50,67</b>	<b>44,15</b>
par 1   by 1	24,16	59,11	51,52
<b>CROIX 17</b>			
par 20   by 20	<b>15,27</b>	<b>41,93</b>	<b>34,85</b>
par 1   by 1	17,42	48,93	40,66

**CERF**  
BOUTON DE TIRAGE | KNOBS

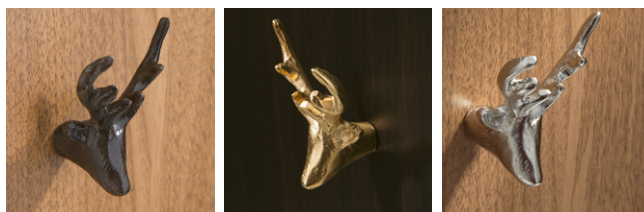

PATINÉ | BROWN

DORÉ | GOLD

NICKELÉ | NICKEL

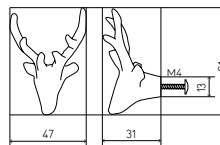

CERF

	PATINÉ BROWN	DORÉ GOLD	NICKELÉ NICKEL
<b>CERF</b>			
par 20   by 20	<b>27,15</b>	<b>60,87</b>	<b>55,26</b>
par 1   by 1	31,02	70,99	64,46

**FRAGILE**  
BOUTON DE TIRAGE | KNOBS



PATINÉ | BROWN

DORÉ | GOLD

NICKELÉ | NICKEL

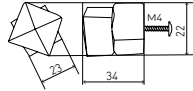

FRAGILE 23

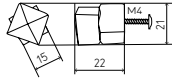

FRAGILE 15

FRAGILE 23	PATINÉ BROWN	DORÉ GOLD	NICKELÉ NICKEL
par 20   by 20	<b>37,66</b>	<b>69,92</b>	<b>64,31</b>
par 1   by 1	43,05	81,55	75,00
FRAGILE 15			
par 20   by 20	<b>19,32</b>	<b>45,39</b>	<b>38,32</b>
par 1   by 1	22,04	52,95	44,68

**FAGOT**  
BOUTON DE TIRAGE | KNOBS



PATINÉ | BROWN

DORÉ | GOLD

NICKELÉ | NICKEL

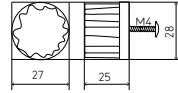

FAGOT 27

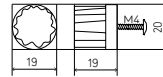

FAGOT 19

FAGOT 27	PATINÉ BROWN	DORÉ GOLD	NICKELÉ NICKEL
par 20   by 20	<b>32,91</b>	<b>65,80</b>	<b>60,19</b>
par 1   by 1	37,60	76,78	70,22
FAGOT 19			
par 20   by 20	<b>18,92</b>	<b>45,08</b>	<b>37,99</b>
par 1   by 1	21,65	52,60	44,35

**FOSSILE**  
BOUTON DE TIRAGE | KNOBS



PATINÉ | BROWN

DORÉ | GOLD

NICKELÉ | NICKEL

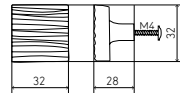

FOSSILE 32

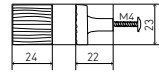

FOSSILE 24

FOSSILE 32	PATINÉ BROWN	DORÉ GOLD	NICKELÉ NICKEL
par 20   by 20	<b>26,47</b>	<b>60,28</b>	<b>54,67</b>
par 1   by 1	30,25	70,33	63,80
FOSSILE 24			
par 20   by 20	<b>17,64</b>	<b>43,98</b>	<b>36,89</b>
par 1   by 1	20,17	50,60	43,05

**BULL**  
BOUTON DE TIRAGE | KNOBS

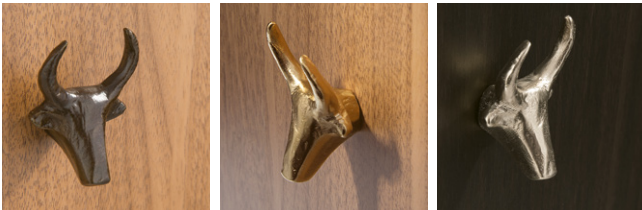

PATINÉ | BROWN

DORÉ | GOLD

NICKELÉ | NICKEL

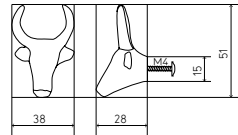

BULL

BULL	PATINÉ BROWN	DORÉ GOLD	NICKELÉ NICKEL
par 20   by 20	<b>26,58</b>	<b>60,41</b>	<b>54,80</b>
par 1   by 1	30,38	70,47	63,93

**LIANE**  
BOUTON DE TIRAGE | KNOBS



PATINÉ | BROWN

DORÉ | GOLD

NICKELÉ | NICKEL

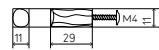

LIANE 29

LIANE	PATINÉ BROWN	DORÉ GOLD	NICKELÉ NICKEL
par 20   by 20	<b>15,44</b>	<b>42,09</b>	<b>35,00</b>
par 1   by 1	17,64	49,10	40,85

**OLIVE**  
BOUTON DE TIRAGE | KNOBS

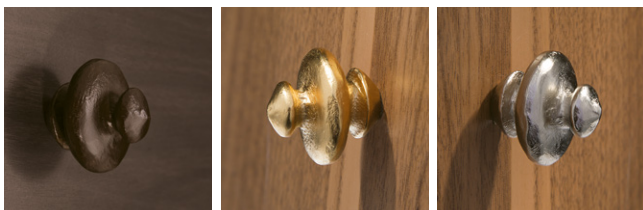

PATINÉ | BROWN

DORÉ | GOLD

NICKELÉ | NICKEL

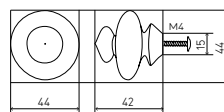

OLIVE 44

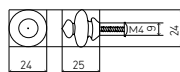

OLIVE 24

OLIVE 44	PATINÉ BROWN	DORÉ GOLD	NICKELÉ NICKEL
par 20   by 20	<b>45,96</b>	<b>77,00</b>	<b>71,41</b>
par 1   by 1	52,54	89,80	83,27
OLIVE 24			
par 20   by 20	<b>17,69</b>	<b>43,98</b>	<b>36,89</b>
par 1   by 1	20,17	51,30	43,05

PENDULE  
BOUTON DE TIRAGE | KNOBS

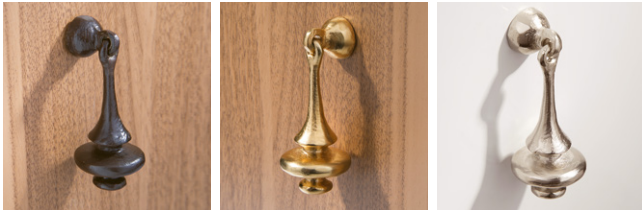

PATINÉ | BROWN

DORÉ | GOLD

NICKELÉ | NICKEL

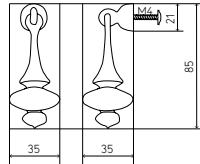

PENDULE 85

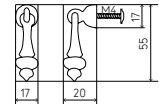

PENDULE 55

PENDULE 85	PATINÉ BROWN	DORÉ GOLD	NICKELÉ NICKEL
par 20   by 20	<b>43,56</b>	<b>83,34</b>	<b>76,27</b>
par 1   by 1	49,79	97,24	88,97
PENDULE 55			
par 20   by 20	<b>22,97</b>	<b>52,25</b>	<b>45,76</b>
par 1   by 1	26,27	60,96	53,37

SÈVE  
BOUTON DE TIRAGE | KNOBS

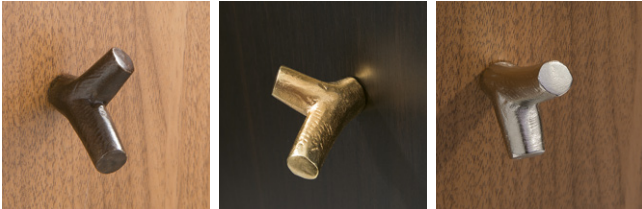

PATINÉ | BROWN

DORÉ | GOLD

NICKELÉ | NICKEL

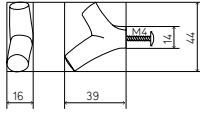

SÈVE 44



SÈVE 29

SÈVE 44	PATINÉ BROWN	DORÉ GOLD	NICKELÉ NICKEL
par 20   by 20	<b>24,64</b>	<b>53,68</b>	<b>47,17</b>
par 1   by 1	28,14	62,61	55,02
SÈVE 29			
par 20   by 20	<b>14,70</b>	<b>41,45</b>	<b>34,39</b>
par 1   by 1	16,81	48,36	40,13

PENDELOQUE  
BOUTON DE TIRAGE | KNOBS



PATINÉ | BROWN

DORÉ | GOLD

NICKELÉ | NICKEL

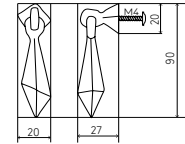

PENDELOQUE 90

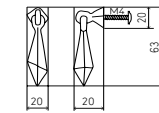

PENDELOQUE 63

PENDELOQUE 90	PATINÉ BROWN	DORÉ GOLD	NICKELÉ NICKEL
par 20   by 20	<b>33,44</b>	<b>74,69</b>	<b>67,63</b>
par 1   by 1	38,24	87,12	78,85
PENDELOQUE 63			
par 20   by 20	<b>22,44</b>	<b>51,81</b>	<b>45,28</b>
par 1   by 1	25,63	60,41	52,82

PLEATS  
BOUTON DE TIRAGE | KNOBS



PATINÉ | BROWN

DORÉ | GOLD

NICKELÉ | NICKEL

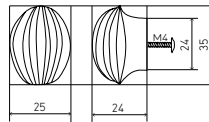

PLEATS 35

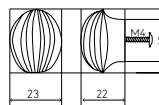

PLEATS 29

PLEATS 35	PATINÉ BROWN	DORÉ GOLD	NICKELÉ NICKEL
par 20   by 20	<b>24,99</b>	<b>53,97</b>	<b>47,48</b>
par 1   by 1	28,58	62,99	55,37
PLEATS 29			
par 20   by 20	<b>20,57</b>	<b>46,51</b>	<b>39,42</b>
par 1   by 1	23,52	54,25	46,00

SABLE  
BOUTON DE TIRAGE | KNOBS



PATINÉ | BROWN

DORÉ | GOLD

NICKELÉ | NICKEL

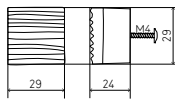

SABLE 29

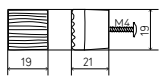

SABLE 19

SABLE 29	PATINÉ BROWN	DORÉ GOLD	NICKELÉ NICKEL
par 20   by 20	<b>25,39</b>	<b>59,36</b>	<b>53,75</b>
par 1   by 1	28,97	69,23	62,70
SABLE 19			
par 20   by 20	<b>18,02</b>	<b>44,31</b>	<b>37,22</b>
par 1   by 1	20,57	51,66	43,41

AKA  
BOUTON DE TIRAGE | KNOBS

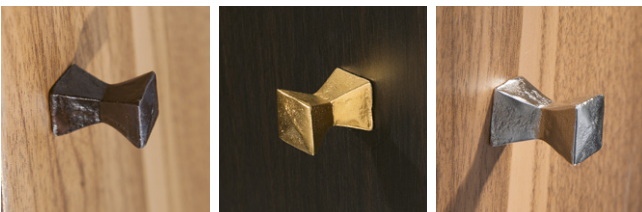

PATINÉ | BROWN

DORÉ | GOLD

NICKELÉ | NICKEL



AKA 23

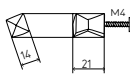

AKA 14

AKA 23	PATINÉ BROWN	DORÉ GOLD	NICKELÉ NICKEL
par 20   by 20	<b>21,49</b>	<b>51,02</b>	<b>44,48</b>
par 1   by 1	24,60	59,49	51,90
AKA 14			
par 20   by 20	<b>15,07</b>	<b>41,78</b>	<b>34,72</b>
par 1   by 1	17,23	48,75	40,48

**SABLE**  
POIGNÉES DE TIRAGE | PULLS



PATINÉ | BROWN

DORÉ | GOLD

NICKELÉ | NICKEL

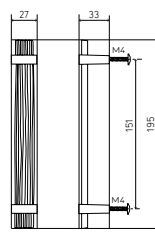

SABLE 195

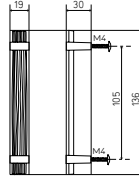

SABLE 136



SABLE 500

SABLE 195	PATINÉ BROWN	DORÉ GOLD	NICKELÉ NICKEL
par 10   by 10	<b>67,08</b>	<b>147,55</b>	<b>135,43</b>
par 1   by 1	76,69	172,13	158,00
SABLE 136			
par 10   by 10	<b>42,83</b>	<b>103,11</b>	<b>93,85</b>
par 1   by 1	48,95	120,27	114,16
SABLE 500			
par 1   by 1	<b>460,00</b>	<b>879,21</b>	<b>747,78</b>

**RING**  
POIGNÉES DE TIRAGE | PULLS



PATINÉ | BROWN

DORÉ | GOLD

NICKELÉ | NICKEL

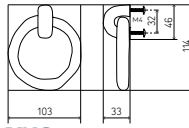

RING 103

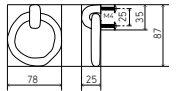

RING 78

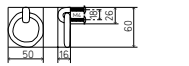

RING 50

RING 103	PATINÉ BROWN	DORÉ GOLD	NICKELÉ NICKEL
par 10   by 10	<b>102,92</b>	<b>191,11</b>	<b>172,41</b>
par 1   by 1	117,83	222,95	201,15
RING 78			
par 10   by 10	<b>54,41</b>	<b>119,11</b>	<b>104,96</b>
par 1   by 1	62,17	138,97	122,45
RING 50			
par 10   by 10	<b>16,04</b>	<b>72,62</b>	<b>59,82</b>
par 1   by 1	18,33	84,72	69,78

**FAGOT**  
POIGNÉES DE TIRAGE | PULLS



PATINÉ | BROWN

DORÉ | GOLD

NICKELÉ | NICKEL

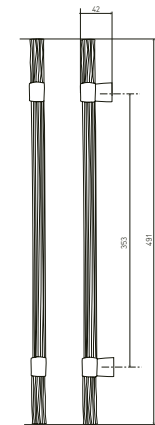

FAGOT 491

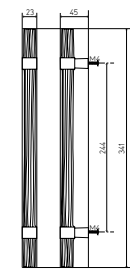

FAGOT 341

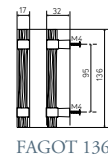

FAGOT 136

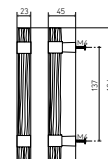

FAGOT 194

FAGOT 341	PATINÉ BROWN	DORÉ GOLD	NICKELÉ NICKEL
par 10   by 10	<b>149,80</b>	<b>313,46</b>	<b>289,30</b>
par 1   by 1	171,20	365,71	337,52
FAGOT 194			
par 10   by 10	<b>97,59</b>	<b>173,69</b>	<b>161,59</b>
par 1   by 1	111,54	202,64	188,52
FAGOT 136			
par 10   by 10	<b>43,01</b>	<b>103,27</b>	<b>94,01</b>
par 1   by 1	49,15	120,45	109,67
FAGOT 491			
par 1   by 1	<b>351,23</b>	<b>772,71</b>	<b>641,28</b>

**ÉCAILLE**  
POIGNÉES DE TIRAGE | PULLS

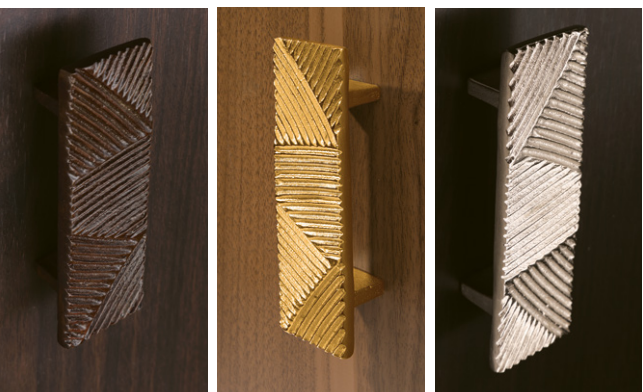

PATINÉ | BROWN

DORÉ | GOLD

NICKELÉ | NICKEL

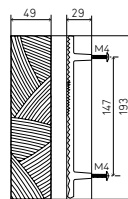

ÉCAILLE 193

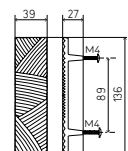

ÉCAILLE 136

ÉCAILLE 193	PATINÉ BROWN	DORÉ GOLD	NICKELÉ NICKEL
par 10   by 10	<b>110,29</b>	<b>223,50</b>	<b>202,42</b>
par 1   by 1	126,04	260,74	237,73
ÉCAILLE 136			
par 10   by 10	<b>76,27</b>	<b>168,45</b>	<b>151,27</b>
par 1   by 1	87,16	196,53	176,53

## PLEATS

POIGNÉES DE TIRAGE | PULLS



PATINÉ | BROWN

DORÉ | GOLD

NICKELÉ | NICKEL

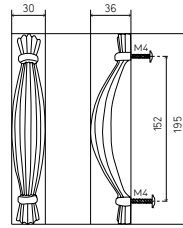

PLEATS 195

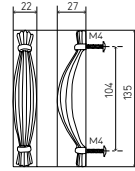

PLEATS 135

PLEATS 195	PATINÉ BROWN	DORÉ GOLD	NICKELÉ NICKEL
par 10   by 10	<b>65,45</b>	<b>146,12</b>	<b>134,00</b>
par 1   by 1	74,78	170,50	156,35

PLEATS 135	PATINÉ BROWN	DORÉ GOLD	NICKELÉ NICKEL
par 10   by 10	<b>33,64</b>	<b>95,19</b>	<b>85,95</b>
par 1   by 1	38,43	111,08	100,30

## GALON

POIGNÉES DE TIRAGE | PULLS



PATINÉ | BROWN

DORÉ | GOLD

NICKELÉ | NICKEL

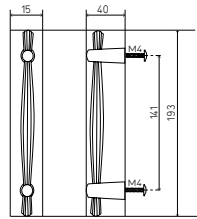

GALON 193

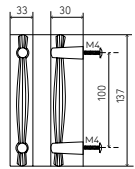

GALON 137

GALON 193	PATINÉ BROWN	DORÉ GOLD	NICKELÉ NICKEL
par 10   by 10	<b>57,53</b>	<b>139,37</b>	<b>127,25</b>
par 1   by 1	65,76	162,58	148,46

GALON 137	PATINÉ BROWN	DORÉ GOLD	NICKELÉ NICKEL
par 10   by 10	<b>39,71</b>	<b>100,41</b>	<b>91,17</b>
par 1   by 1	45,36	117,15	106,37

## LIANE

POIGNÉES DE TIRAGE | PULLS



PATINÉ | BROWN

DORÉ | GOLD

NICKELÉ | NICKEL

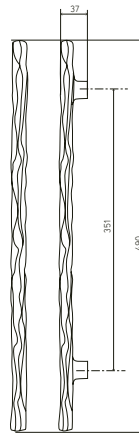

LIANE 490

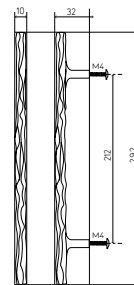

LIANE 292

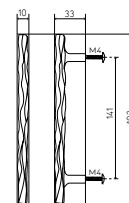

LIANE 192

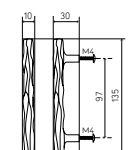

LIANE 135

LIANE 292	PATINÉ BROWN	DORÉ GOLD	NICKELÉ NICKEL
par 10   by 10	<b>64,13</b>	<b>173,12</b>	<b>157,15</b>
par 1   by 1	73,30	201,96	183,35

LIANE 192	PATINÉ BROWN	DORÉ GOLD	NICKELÉ NICKEL
par 10   by 10	<b>45,21</b>	<b>128,83</b>	<b>116,71</b>
par 1   by 1	51,66	150,26	136,14

LIANE 135	PATINÉ BROWN	DORÉ GOLD	NICKELÉ NICKEL
par 10   by 10	<b>36,21</b>	<b>97,42</b>	<b>88,18</b>
par 1   by 1	41,38	113,63	102,85

LIANE 490	PATINÉ BROWN	DORÉ GOLD	NICKELÉ NICKEL
par 1   by 1	18,26	50,15	45,39

## FRAGILE

POIGNÉES DE TIRAGE | PULLS



PATINÉ | BROWN

DORÉ | GOLD

NICKELÉ | NICKEL

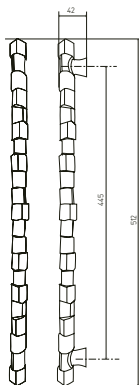

FRAGILE 512

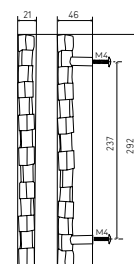

FRAGILE 292

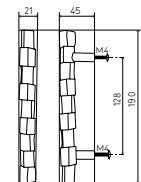

FRAGILE 190

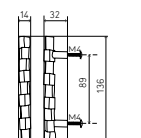

FRAGILE 136

FRAGILE 292	PATINÉ BROWN	DORÉ GOLD	NICKELÉ NICKEL
par 10   by 20	<b>128,66</b>	<b>282,66</b>	<b>250,73</b>
par 1   by 1	147,05	329,80	292,53

FRAGILE 190	PATINÉ BROWN	DORÉ GOLD	NICKELÉ NICKEL
par 10   by 10	<b>86,94</b>	<b>164,58</b>	<b>152,46</b>
par 1   by 1	99,37	191,99	177,85

FRAGILE 136	PATINÉ BROWN	DORÉ GOLD	NICKELÉ NICKEL
par 10   by 10	<b>40,79</b>	<b>101,35</b>	<b>92,11</b>
par 1   by 1	46,64	118,25	107,45

FRAGILE 512	PATINÉ BROWN	DORÉ GOLD	NICKELÉ NICKEL
par 1   by 1	<b>450,93</b>	<b>874,68</b>	<b>747,78</b>

ONDES  
POIGNÉES DE TIRAGE | PULLS

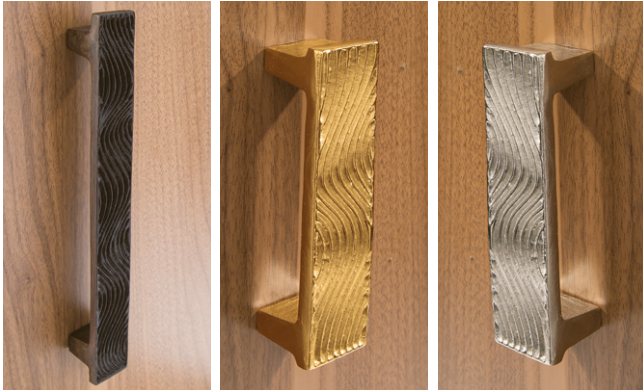

PATINÉ | BROWN

DORÉ | GOLD

NICKELÉ | NICKEL

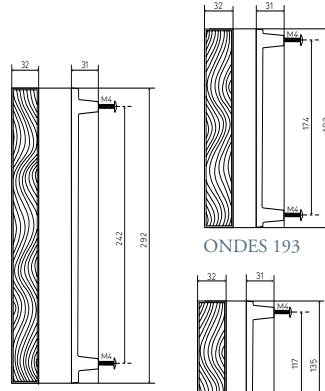

ONDES 292

ONDES 193

ONDES 135

	PATINÉ BROWN	DORÉ GOLD	NICKELÉ NICKEL
ONDES 292			
par 10   by 10	<b>140,05</b>	<b>292,47</b>	<b>260,55</b>
par 1   by 1	160,07	341,24	303,97
ONDES 193			
par 10   by 10	<b>108,44</b>	<b>221,94</b>	<b>200,86</b>
par 1   by 1	123,93	258,92	234,32
ONDES 135			
par 10   by 10	<b>85,10</b>	<b>173,67</b>	<b>158,84</b>
par 1   by 1	97,26	205,35	185,33

AGAVE  
POIGNÉES DE TIRAGE | PULLS



PATINÉ | BROWN

DORÉ | GOLD

NICKELÉ | NICKEL

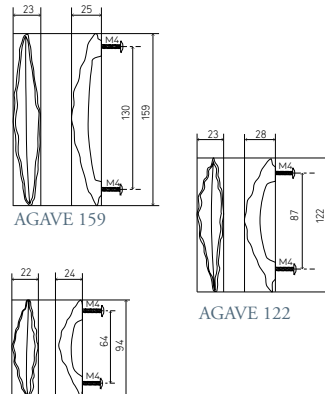

AGAVE 159

AGAVE 122

	PATINÉ BROWN	DORÉ GOLD	NICKELÉ NICKEL
AGAVE 159			
par 10   by 10	<b>29,02</b>	<b>91,28</b>	<b>82,04</b>
par 1   by 1	33,20	106,48	98,03
AGAVE 122			
par 10   by 10	<b>28,12</b>	<b>87,76</b>	<b>76,21</b>
par 1   by 1	32,14	102,39	88,90
AGAVE 94			
par 10   by 10	<b>24,09</b>	<b>79,20</b>	<b>67,72</b>
par 1   by 1	27,50	92,40	79,02

FOSSILE  
POIGNÉES DE TIRAGE | PULLS



PATINÉ | BROWN

DORÉ | GOLD

NICKELÉ | NICKEL

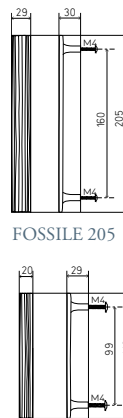

FOSSILE 205

FOSSILE 146

	PATINÉ BROWN	DORÉ GOLD	NICKELÉ NICKEL
FOSSILE 205			
par 10   by 10	<b>33,92</b>	<b>70,01</b>	<b>64,50</b>
par 1   by 1	38,77	81,67	75,25
FOSSILE 146			
par 10   by 10	<b>20,47</b>	<b>47,72</b>	<b>43,52</b>
par 1   by 1	23,39	55,66	50,77

# POIGNÉE DE PORTE | HANDLES

## FAGOT

POIGNÉES DE PORTE | HANDLES



PATINÉ | BROWN



DORÉ | GOLD



NICKELÉ | NICKEL

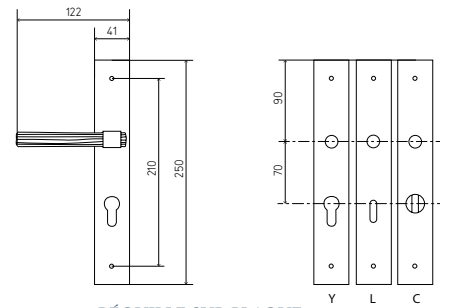

BÉQUILLE SUR PLAQUE

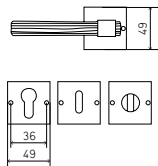

BÉQUILLE SUR ROSACE

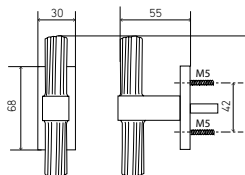

POIGNÉE DE FENÊTRE

FAGOT	PATINÉ BROWN	DORÉ GOLD	NICKELÉ NICKEL
PAIRE DE BÉQUILLE SUR ROSACE	232,39	377,32	347,20
PAIRE DE BÉQUILLE SUR PLAQUE L OU Y	332,66	554,64	519,64
PAIRE BÉQUILLE SUR PLAQUE CONDA	372,09	621,24	579,15
PAIRE ENTRÉE DE SERRURE L OU Y	42,77	75,46	67,63
PAIRE ENTRÉE DE SERRURE CONDA	86,86	151,05	131,78
POIGNÉE DE FENÊTRE	112,97	183,48	169,47

## GALON

POIGNÉES DE PORTE | HANDLES

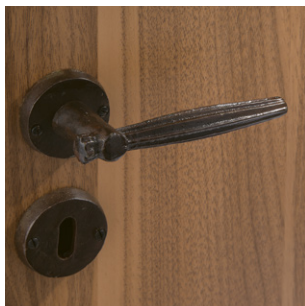

PATINÉ | BROWN



DORÉ | GOLD



NICKELÉ | NICKEL

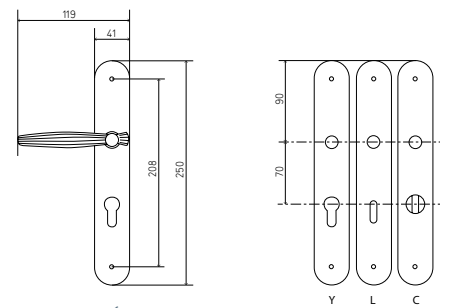

BÉQUILLE SUR PLAQUE

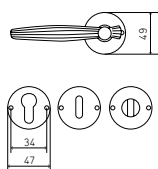

BÉQUILLE SUR ROSACE

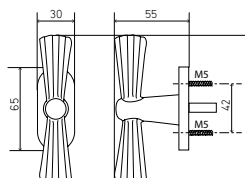

POIGNÉE DE FENÊTRE

GALON	PATINÉ BROWN	DORÉ GOLD	NICKELÉ NICKEL
PAIRE DE BÉQUILLE SUR ROSACE	216,61	361,57	331,45
PAIRE DE BÉQUILLE SUR PLAQUE L OU Y	316,91	538,89	503,89
PAIRE BÉQUILLE SUR PLAQUE CONDA	356,33	605,48	563,40
PAIRE ENTRÉE DE SERRURE L OU Y	36,12	68,82	60,98
PAIRE ENTRÉE DE SERRURE CONDA	79,29	143,48	124,23
POIGNÉE DE FENÊTRE	107,45	177,98	163,97

## ONDES

POIGNÉES DE PORTE | HANDLES

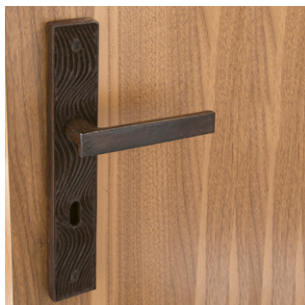

PATINÉ | BROWN



DORÉ | GOLD



NICKELÉ | NICKEL

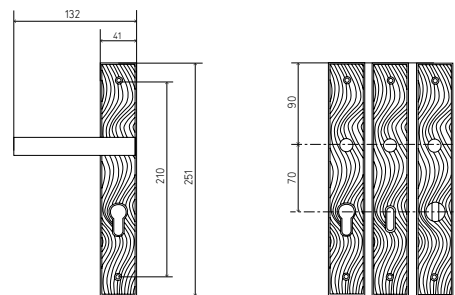

BÉQUILLE SUR PLAQUE

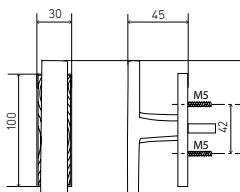

POIGNÉE DE FENÊTRE

### ONDES

	PATINÉ BROWN	DORÉ GOLD	NICKELÉ NICKEL
PAIRE DE BÉQUILLE SUR PLAQUE L OU Y	317,53	539,51	504,50
PAIRE BÉQUILLE SUR PLAQUE CONDA	356,97	606,10	564,04
POIGNÉE DE FENÊTRE	107,93	178,42	164,43

## FOSSILE

POIGNÉES DE PORTE | HANDLES

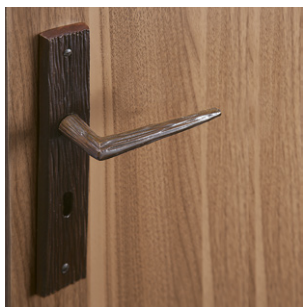

PATINÉ | BROWN

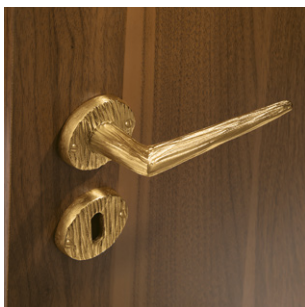

DORÉ | GOLD

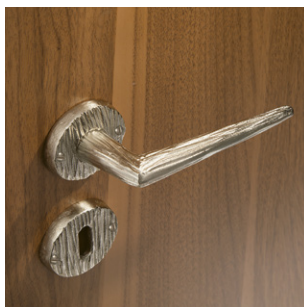

NICKELÉ | NICKEL

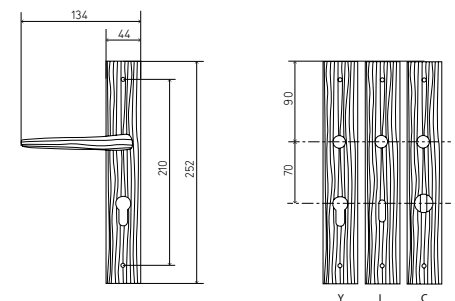

BÉQUILLE SUR PLAQUE

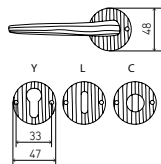

BÉQUILLE SUR ROSACE

### FOSSILE

	PATINÉ BROWN	DORÉ GOLD	NICKELÉ NICKEL
PAIRE DE BÉQUILLE SUR ROSACE	210,94	355,87	325,78
PAIRE DE BÉQUILLE SUR PLAQUE L OU Y	306,81	528,81	493,81
PAIRE BÉQUILLE SUR PLAQUE CONDA	346,24	595,39	553,32
PAIRE ENTRÉE DE SERRURE L OU Y	30,45	63,16	55,31
PAIRE ENTRÉE DE SERRURE CONDA	73,92	138,14	118,87

## LIANE

POIGNÉES DE PORTE | HANDLES

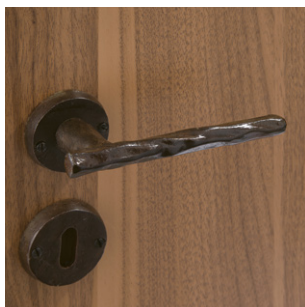

PATINÉ | BROWN

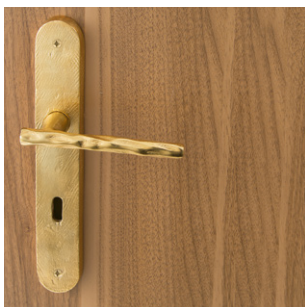

DORÉ | GOLD



NICKELÉ | NICKEL

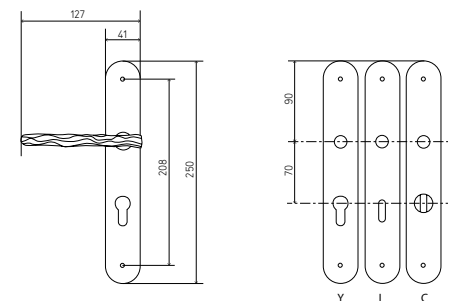

BÉQUILLE SUR PLAQUE

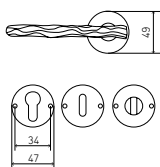

BÉQUILLE SUR ROSACE

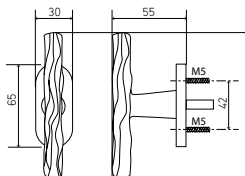

POIGNÉE DE FENÊTRE

### LIANE

	PATINÉ BROWN	DORÉ GOLD	NICKELÉ NICKEL
PAIRE DE BÉQUILLE SUR ROSACE	212,85	357,79	327,67
PAIRE DE BÉQUILLE SUR PLAQUE L OU Y	313,13	535,11	500,10
PAIRE BÉQUILLE SUR PLAQUE CONDA	352,55	601,70	559,61
PAIRE ENTRÉE DE SERRURE L OU Y	36,12	68,82	60,98
PAIRE ENTRÉE DE SERRURE CONDA	79,29	143,48	124,23
POIGNÉE DE FENÊTRE	98,65	169,14	155,12

## SABLE

POIGNÉES DE PORTE | HANDLES



PATINÉ | BROWN



DORÉ | GOLD



NICKELÉ | NICKEL

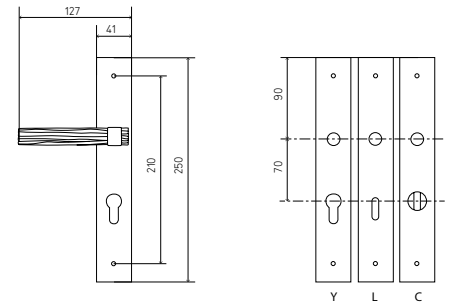

BÉQUILLE SUR PLAQUE

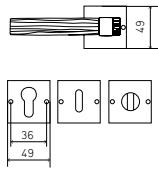

BÉQUILLE SUR ROSACE

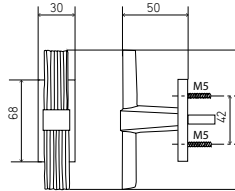

POIGNÉE DE FENÊTRE

## SABLE

	PATINÉ BROWN	DORÉ GOLD	NICKELÉ NICKEL
PAIRE DE BÉQUILLE SUR ROSACE	232,03	377,01	346,90
PAIRE DE BÉQUILLE SUR PLAQUE L OU Y	332,35	554,33	519,33
PAIRE BÉQUILLE SUR PLAQUE CONDA	371,78	620,93	578,84
PAIRE ENTRÉE DE SERRURE L OU Y	42,77	75,46	67,65
PAIRE ENTRÉE DE SERRURE CONDA	86,86	151,05	131,78
POIGNÉE DE FENÊTRE	109,52	180,00	166,01

## FRAGILE

POIGNÉES DE PORTE | HANDLES



PATINÉ | BROWN



DORÉ | GOLD



NICKELÉ | NICKEL

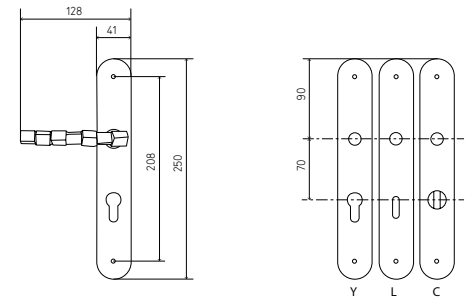

BÉQUILLE SUR PLAQUE

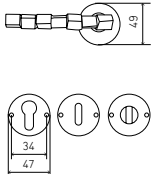

BÉQUILLE SUR ROSACE

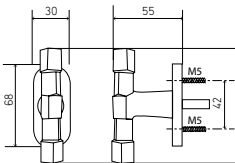

POIGNÉE DE FENÊTRE

## FRAGILE

	PATINÉ BROWN	DORÉ GOLD	NICKELÉ NICKEL
PAIRE DE BÉQUILLE SUR ROSACE	229,22	374,15	344,04
PAIRE DE BÉQUILLE SUR PLAQUE L OU Y	329,52	551,50	516,49
PAIRE BÉQUILLE SUR PLAQUE CONDA	368,92	618,07	576,00
PAIRE ENTRÉE DE SERRURE L OU Y	36,12	68,82	60,98
PAIRE ENTRÉE DE SERRURE CONDA	79,29	143,48	124,23
POIGNÉE DE FENÊTRE	106,02	176,55	162,54

## PLEATS

POIGNÉES DE PORTE | HANDLES



PATINÉ | BROWN

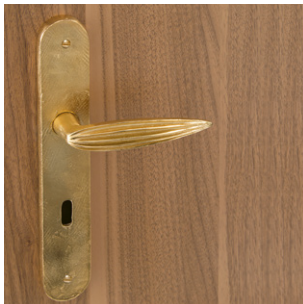

DORÉ | GOLD



NICKELÉ | NICKEL

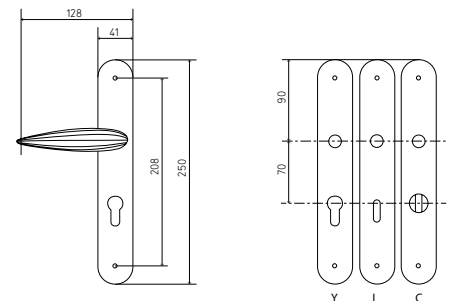

BÉQUILLE SUR PLAQUE

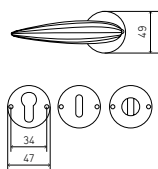

BÉQUILLE SUR ROSACE

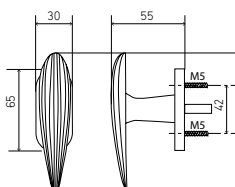

POIGNÉE DE FENÊTRE

## PLEATS

	PATINÉ BROWN	DORÉ GOLD	NICKELÉ NICKEL
PAIRE DE BÉQUILLE SUR ROSACE	214,41	359,37	329,25
PAIRE DE BÉQUILLE SUR PLAQUE L OU Y	314,73	536,69	501,67
PAIRE BÉQUILLE SUR PLAQUE CONDA	354,13	603,28	561,20
PAIRE ENTRÉE DE SERRURE L OU Y	36,12	68,82	60,98
PAIRE ENTRÉE DE SERRURE CONDA	79,29	143,48	124,23
POIGNÉE DE FENÊTRE	99,09	169,62	155,61

# TRINGLES À RIDEAUX | CURTAIN RODS

**PLUME**  
EMBOUT | FINIAL

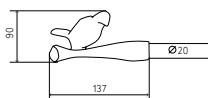

EMBOUT PLUME 20

**VIDE**  
EMBOUT | FINIAL

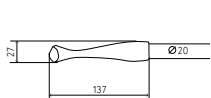

EMBOUT VIDE 20

**SIMPLE**  
EMBOUT | FINIAL

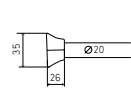

EMBOUT SIMPLE 20

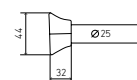

EMBOUT SIMPLE 25

**GARDE**  
EMBOUT | FINIAL

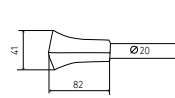

EMBOUT GARDE 20

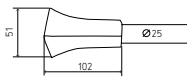

EMBOUT GARDE 25

	20 mm	25 mm
TRINGLE EN LAITON PATINÉ	75,26	83,29
EMBOUT PLUME	207,06	
EMBOUT VIDE	94,56	
EMBOUT SIMPLE	36,98	58,78
EMBOUT GARDE	75,46	111,61
EMBOUT CROSSE	49,81	72,91
EMBOUT OLIVE	162,62	225,70
EMBOUT ORBE	40,81	53,66
EMBOUT FRAGILE	80,85	125,47
SUPPORT SIMPLE COURT	64,99	66,68
SUPPORT SIMPLE NORMAL	81,73	83,25
SUPPORT SIMPLE LONG	94,23	95,72
SUPPORT NAISSANCE	42,22	62,55
SUPPORT DOUBLE	87,12	87,78
SUPPORT RALLONGE COURT	79,13	80,83
SUPPORT RALLONGE NORMAL	95,88	97,39
SUPPORT RALLONGE LONG	108,33	109,82
SUPPORT DOUBLE RALLONGE	110,48	111,14

**CROSSE**  
EMBOUT | FINIAL

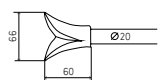

EMBOUT CROSSE 20

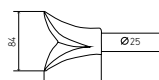

EMBOUT CROSSE 25

**OLIVE**  
EMBOUT | FINIAL

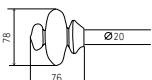

EMBOUT OLIVE 20

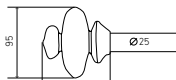

EMBOUT OLIVE 25

**ORBE**  
EMBOUT | FINIAL

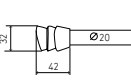

EMBOUT ORBE 20

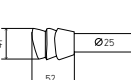

EMBOUT ORBE 25

**FRAGILE**  
EMBOUT | FINIAL

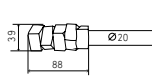

EMBOUT FRAGILE 20

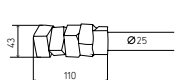

EMBOUT FRAGILE 25

CROCHET D'EMBRASSE 120	67,78
CROCHET D'EMBRASSE 175	108,26
CROCHET D'EMBRASSE FIX	132,22
ANNEAU 40	3,17
ANNEAU 50	3,87
ANNEAU 60	4,71

**SUPPORT BRACKET**

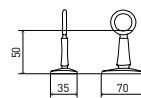

SUPPORT SIMPLE COURT

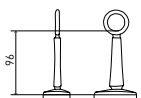

SUPPORT SIMPLE NORMAL

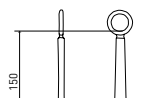

SUPPORT SIMPLE LONG

**NAISSANCE BRACKET**

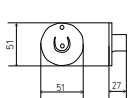

SUPPORT NAISSANCE 20

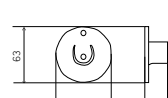

SUPPORT NAISSANCE 25

**DOUBLE BRACKET**

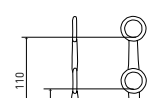

SUPPORT DOUBLE

**RALLONGE BRACKET**

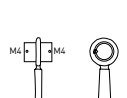

SUPPORT RALLONGE

**CROCHET TIE BACKS**

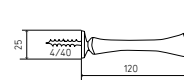
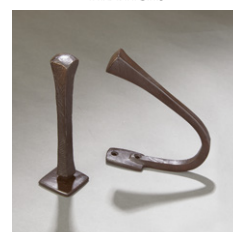

CROCHET D'EMBRASSE 120

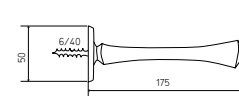

CROCHET D'EMBRASSE 175

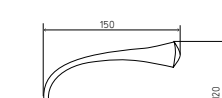

CROCHET D'EMBRASSE FIX